

# GV-BX4802 AI 4MP H.265 Super Low Lux WDR Pro Box IP Camera



- 1/3" progressive scan CMOS sensor
- Min. illumination at 0.0028 lux
- Triple streams from H.265, H.264, and MJPEG
- Up to 30 fps at 2592 x 1520
- Day and Night function (with removable IR-cut filter)
- Wide Dynamic Range Pro (WDR Pro)
- Wide temperature tolerance -30°C ~60°C (-22°F ~ 140°F)
- Built-in microphone
- Two-way audio
- Built-in micro SD card slot (SD / SDHC / SDXC / UHS-I, Class 10) for local storage
- AC 24V / DC 12V / PoE (IEEE 802.3af)
- AI analytics (Line Crossing, Region Entrance, Region Exiting, Target Counting, Region Intrusion, Face Detection)
- Defog
- 3D noise reduction
- Motion detection
- Text overlay
- Privacy mask
- 14 languages supported
- ONVIF (Profile G, S, T) conformant

## Introduction

GV-BX4802 is a 4 MP network camera equipped with an automatic IR-cut filter for day and night surveillance. Fixed / Iris lens are optional for the camera for a more comprehensive performance depending on different needs. GV-BX4802 supports H.265 / H.264 video codec to achieve better compression ratio while maintaining high picture quality at reduced network bandwidths. The camera is equipped with a Super Low Lux CMOS image sensor which allows the camera to provide a color live view in near darkness.

Empowered by deep learning algorithms, AI technology distinguishes human and vehicles from other moving objects. Integrated with GeoVision Video Management Software (GV-VMS), it supports AI perimeter protection, real-time alert, playback and more.

## Deep Learning Function

### Face Detection

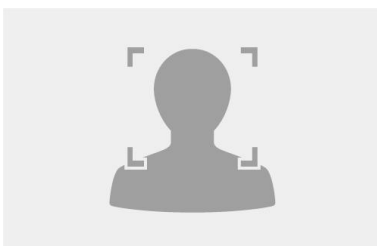

### AI Perimeter Protection

(Intrusion, Crossing Line  
Entering Area, Leaving Area)

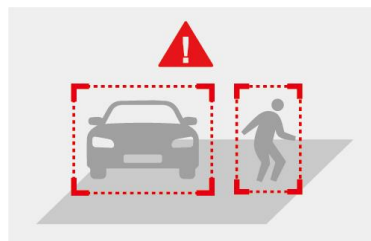

### People Counting

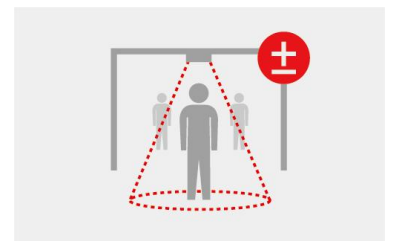

**Note:** The AI function integration of the camera to GV-VMS is coming soon.

## Dimensions

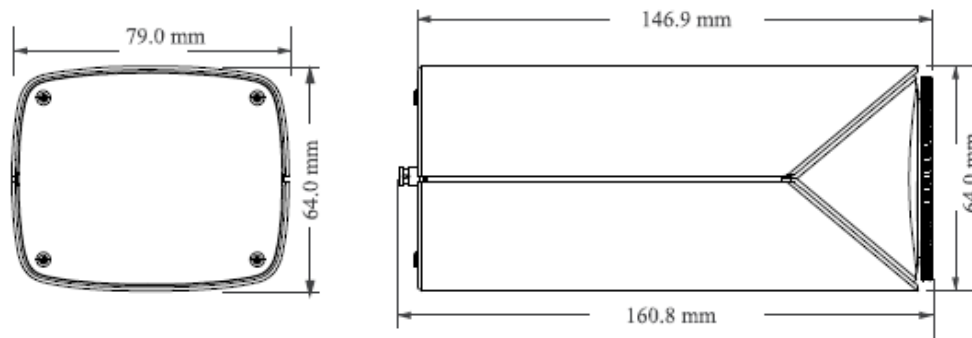

## Specifications

Camera		
Image Sensor		1/3" progressive scan CMOS
Picture Elements		2592 (H) x 1520 (V)
Minimum Illumination	Color	0.0028 Lux (F1.2, AGC ON)
	B/W	0.001 Lux (F1.2, AGC ON)
	IR On	0 Lux
Shutter Speed		Automatic, Manual (1 ~ 1/100000 sec)
White Balance		Automatic, Manual
Gain Control		Automatic, Manual
S/N Ratio		52 dB
WDR Pro		Yes
Dynamic Range		120 dB
Day/Night		Yes (with removable IR-cut filter)
Mount		CS Mount
Iris		DC Iris
Operation		
Video Compression		H.265, H.265+, H.264, H.264+, MJPEG
Video Streaming		Triple streams
Video Resolution	Main Stream	2592 x 1520 (Default), 2560 x 1440, 2304 x 1296, 1920 x 1080, 1280 x 720
	Sub Stream	1280 x 720 (Default), 704 x 480, 352 x 240
	Third Stream	704 x 480, 480 x 240, 352 x 240 (Default)
Frame Rate		30 fps at 2592 x 1520, 30 fps at 2560 x 1440, 30 fps at 2304 x 1296, 30 fps at 1920 x 1080, 30 fps at 1280 x 720, 30 fps at 704 x 480, 30 fps at 352 x 240, 30 fps at 480 x 240 (60 / 50 Hz) HFR Mode: 60 fps at 1920 x 1080, 60 fps at 1280 x 720 (60 / 50 Hz) * The frame rate and performance may vary depending on the number of connections and data bitrates (different scenes).
Video Analytics		Motion Detection, Video Exception Detection (Scene Change, Video Blur and Video Cast Detection), Object Abandoned/Missing Detection, Heat Map
Smart Alarm		Motion Detection, Sensor Alarm, SD Card Error, SD Card Full, IP Address Conflict, Cable Disconnection
Image Setting		Brightness, Contrast, Saturation, Sharpness, Flicker-less, 3D Noise Reduction, Image Orientation (Flip, Mirror, 0°, 90°, 180°, 270°-including Corridor format).
Audio Compression		G.711
Audio Support		Two-way Audio (external speaker required)
Digital I/O	Input	2 Inputs dry contact, NO / NC
	Output	2 Relay Outputs(1A 30V DC / 0.3A 125V AC)
Network		
Interface		10/100 Ethernet
Protocol		UDP, IPv4, IPv6, DHCP, NTP, RTSP, RTMP, PPPoE, DDNS, SMTP, FTP, SNMP, HTTP, HTTP POST, 802.1x, UPnP, HTTPs, QoS, ONVIF

Deep Learning Function		
AI Analytics		-Line Crossing, Region Entrance, Region Exiting, Region Intrusion, Target Counting: Human & Vehicle classification -Face Detection
Mechanical		
Connectors	Power	2-pin terminal block (DC 12 V, 1.25 A), PoE
	Ethernet	RJ-45
	Audio	1 In (built-in or external microphone) 1 Out (stereo phone jack, 3.5 mm / 0.14")
	Digital I/O	8-pin terminal block pitch 2.54 mm (0.1")
	RS-485	2-pin terminal block for PTZ camera
	TV-Out	BNC connector
	Local Storage	Micro SD card slot (SD / SDHC / SDXC / UHS-I, Class 10) * UHS-II card type is not supported.
General		
Operating Temperature		-30~ 60°C (-22 ~ 140°F)
Humidity		0 ~ 95% (no condensation)
Power Source		24V AC / 12V DC / PoE (IEEE802.3af)
Max. Power Consumption		11 W
Dimensions		160.8 x 79 x 64 mm (6.33 x 3.11 x 2.52")
Weight		0.65 kg (1.43 lb)
Regulatory		CE, FCC, RoHS compliant
Web Interface		
Installation Management		Web-based configuration
Maintenance		Firmware upgrade through Web Browser or Utility
Access from Web Browser		Live View, Playback, Video Recording, Image Quality, Bandwidth Control, Image Snapshot, Two-way Audio, Digital Zoom, Text Overlay, Image Masking
Language		Czech, English, German, Hungarian, Italian, Persian, Polish, Romanian, Russian, Spanish, Traditional Chinese, Turkish, Portuguese, Japanese
Software Applications		
Software Supported		GV-VMS (V17.4.5 / V18.3.1, patch files required)
Live Viewing		Web Browser (IE, Edge, Chrome, Firefox, Safari), Mobile APP







**Note:** Specifications are subject to change without notice.

### Packing List

1. GV-BX4802 Box IP Camera (No Lens)
2. 2-Pin Terminal Block
3. Download Guide

**Note:** Users need to purchase camera lens separately.

**Accessories**

Model No.	Details	
Fixed 2.8 mm Lens		Horizontal FOV: 82° Maximum Aperture: F/2.0 Image Format: 1/2.7" Dimension: Ø30 x 18.2 mm (Ø1.18" x 0.71")
DC-Iris 2.8 mm – 12 mm Lens		Horizontal FOV: 126° ~ 55° Maximum Aperture: F/1.8 Image Format: 1/2.7" Dimension: Ø34 x 50.2 mm (Ø1.33" x 1.98")
GV-PA191 PoE Adapter		GV-PA191 is a Power over Ethernet (PoE) adapter designed to provide power to the IP device through a single Ethernet cable.
GV-POE Switch		GV-POE Switch is designed to provide power along with network connection for IP devices. The GV-POE Switch is available in various models with different numbers and types of ports.
GV-Relay V2		GV-Relay V2 is designed to expand the voltage load of GV IP devices. It provides 4 relay outputs, and each can be set as normally open (NO) or normally closed (NC) independently as per your requirement.
Power Adapter		Contact our sales representatives for the countries and areas supported.