

# GV-BX2802 AI 2MP H.265 Super Low Lux WDR Pro Box IP Camera



- 1/2.8" progressive scan CMOS
- Min. illumination at 0.0028 lux
- Triple streams from H.265, H.264, and MJPEG
- Up to 30 fps at 1920 x 1080
- Day and Night function (with removable IR-cut filter)
- Wide Dynamic Range Pro (WDR Pro)
- Wide temperature tolerance -30°C ~ 60°C (-22°F ~ 140°F)
- Built-in microphone
- Two-way audio
- Built-in micro SD card slot (SD / SDHC / SDXC / UHS-I, Class 10) for local storage
- AC 24 V / DC 12V / PoE (IEEE 802.3af)
- AI analytics (Line Crossing, Region Entrance, Region Exiting, Target Counting, Region Intrusion, Crowd Density, Face Detection)
- Defog
- 3D noise reduction
- Motion detection
- Text overlay
- Privacy mask
- 14 languages supported
- ONVIF (Profile G, S, T) conformant

## Introduction

GV-BX2802 is a 2 MP network camera equipped with an automatic IR-cut filter for day and night surveillance. Fixed / Iris lens are optional for the camera for a more comprehensive performance depending on different needs. GV-BX2802 supports H.265 / H.264 video codec to achieve better compression ratio while maintaining high picture quality at reduced network bandwidths. The camera is equipped with a Super Low Lux CMOS image sensor which allows the camera to provide a color live view in near darkness.

Empowered by deep learning algorithms, AI technology distinguishes human and vehicles from other moving objects. Integrated with GeoVision Video Management Software (GV-VMS), it supports AI perimeter protection, real-time alert, playback and more.

## Deep Learning Function

### Face Detection

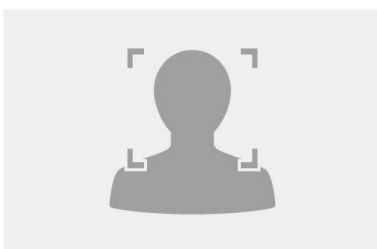

### AI Perimeter Protection

(Intrusion, Crossing Line  
Entering Area, Leaving Area)

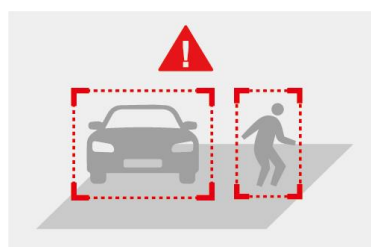

### People Counting

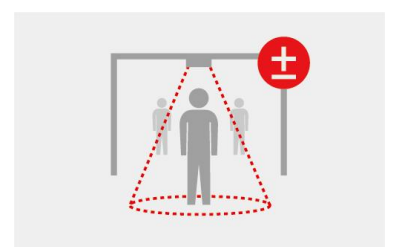

**Note:** The AI function integration of the camera to GV-VMS is coming soon.

## Dimensions

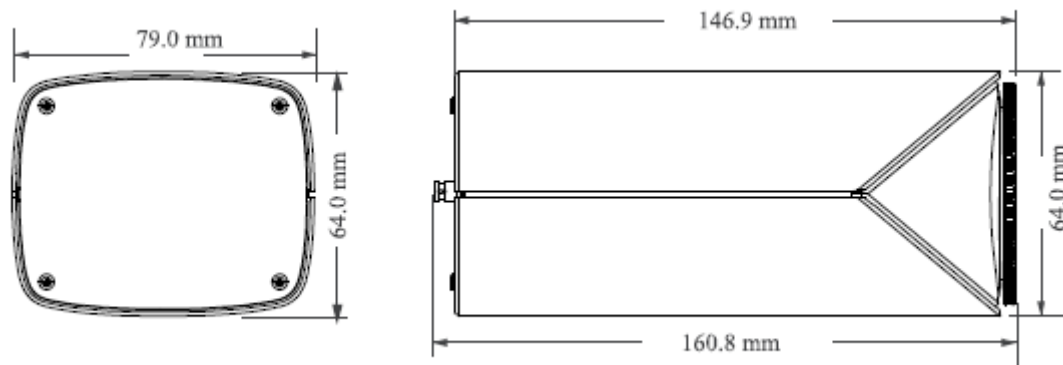

## Specifications

Camera		
Image Sensor	1/2.8" progressive scan CMOS	
Picture Elements	1920 (H) x 1080 (V)	
Minimum Illumination	Color	0.0028 Lux (F1.2, AGC ON)
	B/W	0.002 Lux (F1.2, AGC ON)
	IR On	0 Lux
Shutter Speed	Automatic, Manual (1 ~ 1/100000 sec)	
White Balance	Automatic, Manual	
Gain Control	Automatic, Manual	
S/N Ratio	52 dB	
WDR Pro	Yes	
Dynamic Range	120 dB	
Day/Night	Yes (with removable IR-cut filter)	
Mount	CS Mount	
Iris	DC Iris	
Operation		
Video Compression	H.265, H.265+, H.264, H.264+, MJPEG	
Video Streaming	Triple streams	
Video Resolution	Main Stream	1920 x 1080 (Default), 1280 x 720
	Sub Stream	1280 x 720 (Default), 704 x 480, 352 x 240
	Third Stream	704 x 480, 480 x 240, 352 x 240 (Default)
Frame Rate	30 fps at 1920 x 1080, 30 fps at 1280 x 720, 30 fps at 704 x 480, 30 fps at 352 x 240, 30 fps at 480 x 240 (60 / 50 Hz) (H.265 / H.265+ / H.264 / H.264+) 20 fps at 1280 x 720, 30 fps at 704 x 480, 30 fps at 352 x 240, 30 fps at 480 x 240 (60 / 50 Hz) (MJPEG) * The frame rate and performance may vary depending on the number of connections and data bitrates (different scenes).	
Video Analytics	Motion Detection, Video Exception Detection (Scene Change, Video Blur and Video Cast Detection), Object Abandoned/Missing Detection, Heat Map	
Smart Alarm	Motion Detection, Sensor Alarm, SD Card Error, SD Card Full, IP Address Conflict, Cable Disconnection	
Image Setting	Brightness, Contrast, Saturation, Sharpness, Flicker-less, 3D Noise Reduction, Image Orientation (Flip, Mirror, 0°, 90°, 180°, 270°-including Corridor format).	
Audio Compression	G.711	
Audio Support	Two-way Audio (external speaker required)	
Digital I/O	Input	2 Inputs, dry contact, NO / NC
	Output	2 Relay Outputs (1A 30V DC / 0.3A 125V AC)
Network		
Interface	10/100 Ethernet	

Protocol	UDP, IPv4, IPv6, DHCP, NTP, RTSP, RTMP, PPPoE, DDNS, SMTP, FTP, SNMP, HTTP, HTTP POST, 802.1x, UPnP, HTTPs, QoS, ONVIF	
<b>Deep Learning Function</b>		
AI Analytics	-Line Crossing, Region Entrance, Region Exiting, Region Intrusion, Target Counting: Human & Vehicle classification -Crowd Density, Face Detection	
<b>Mechanical</b>		
Connectors	Power	2-pin terminal block (DC 12 V, 1.25 A), PoE
	Ethernet	RJ-45
	Audio	1 In (built-in or external microphone) 1 Out (stereo phone jack, 3.5 mm / 0.14")
	Digital I/O	8-pin terminal block pitch 2.54 mm (0.1")
	RS-485	2-pin terminal block for PTZ camera
	TV-Out	BNC connector
	Local Storage	Micro SD card slot (SD / SDHC / SDXC / UHS-I, Class 10) *UHS-II card type is not supported.
<b>General</b>		
Operating Temperature	-30 ~ 60°C (-22 ~ 140°F)	
Humidity	0 ~ 95% (no condensation)	
Power Source	24V AC / 12V DC / PoE (IEEE802.3af)	
Max. Power Consumption	11 W	
Dimensions	160.8 x 79 x 64 mm (6.33 x 3.11 x 2.52")	
Weight	0.65 kg (1.43 lb)	
Regulatory	CE, FCC, RoHS compliant	
<b>Web Interface</b>		
Installation Management	Web-based configuration	
Maintenance	Firmware upgrade through Web Browser or Utility	
Access from Web Browser	Live View, Playback, Video Recording, Image Quality, Bandwidth Control, Image Snapshot, Two-way Audio, Digital Zoom, Text Overlay, Image Masking	
Language	Czech, English, German, Hungarian, Italian, Persian, Polish, Romanian, Russian, Spanish, Traditional Chinese, Turkish, Portuguese, Japanese	
<b>Software Applications</b>		
Software Supported	GV-VMS (V17.4.5 / V18.3.1, patch files required)	
Live Viewing	Web Browser (IE, Edge, Chrome, Firefox, Safari), Mobile APP	





**Note:** Specifications are subject to change without notice.

### Packing List

1. GV-BX2802 Box IP Camera (No Lens)
2. 2-Pin Terminal Block
3. Download Guide

**Note:** Users need to purchase camera lens separately.

**Accessories**

Model No.	Details	
Fixed 2.8 mm Lens		Horizontal FOV: 82° Maximum Aperture: F/2.0 Image Format: 1/2.7" Dimension: Ø30 x 18.2 mm (Ø1.18" x 0.71")
DC-Iris 2.8 mm – 12 mm Lens		Horizontal FOV: 126° ~ 55° Maximum Aperture: F/1.8 Image Format: 1/2.7" Dimension: Ø34 x 50.2 mm (Ø1.33" x 1.98")
GV-PA191		GV-PA191 is a Power over Ethernet (PoE) adapter designed to provide power to the IP device through a single Ethernet cable.
GV-POE Switch		GV-POE Switch is designed to provide power along with network connection for IP devices. The GV-POE Switch is available in various models with different numbers and types of ports.
GV-Relay V2		GV-Relay V2 is designed to expand the voltage load of GV IP devices. It provides 4 relay outputs, and each can be set as normally open (NO) or normally closed (NC) independently as per your requirement.
Power Adapter		Contact our sales representatives for the countries and areas supported.